

*Applying grease from many angles at high speed with pinpoint shooting!*

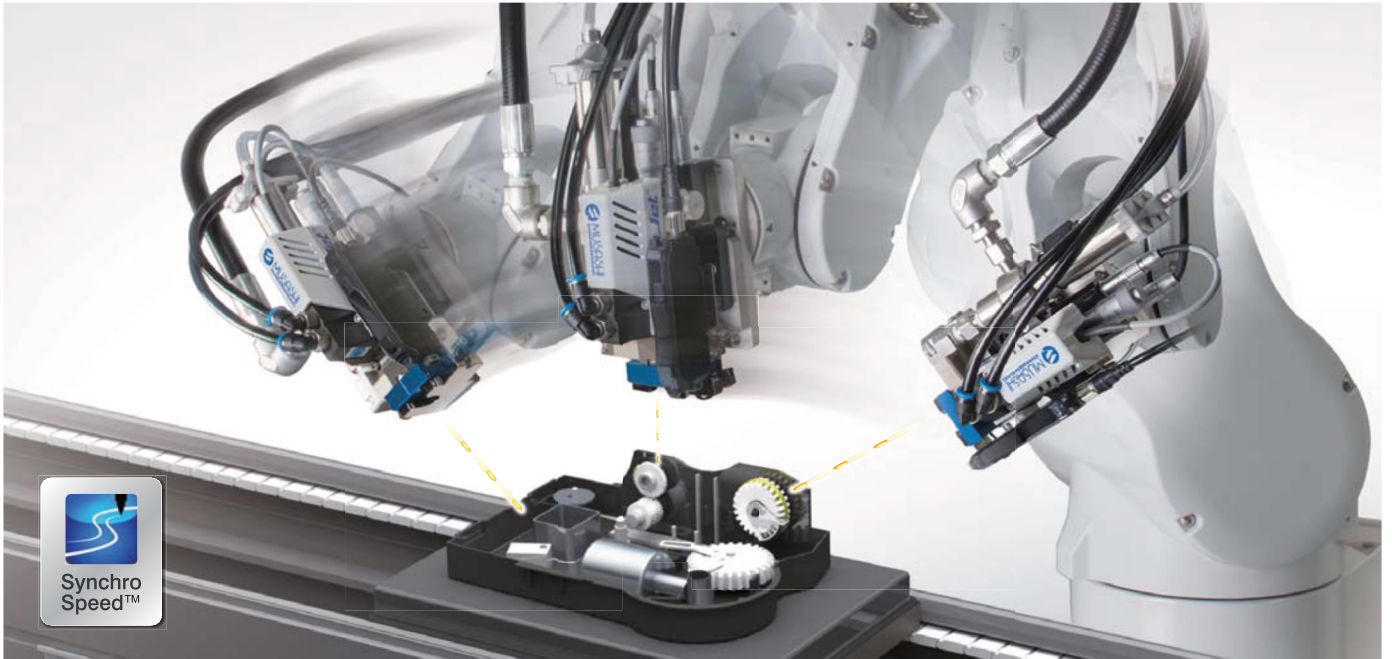

**Continuous dispensing**  
of an entire can of grease  
Helps to reduce on running costs.

Setup the system by directly connecting it to the can

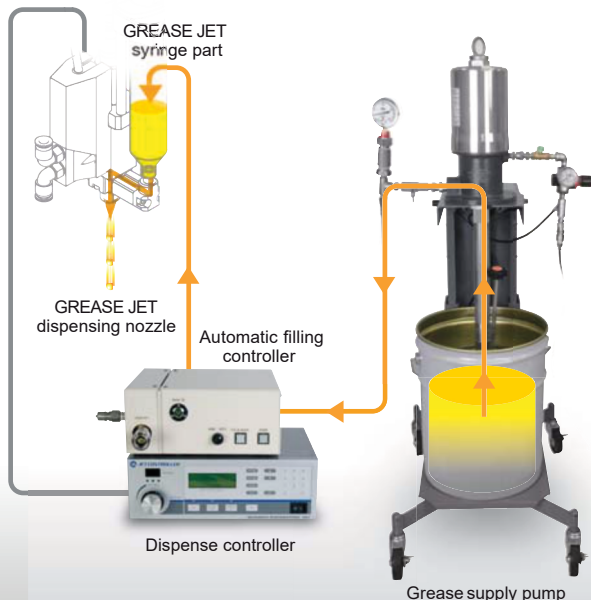

**Pinpoint shooting of fixed volumes**  
with non-contact JET

Dispense from any direction  
- underside, side, or oblique angles

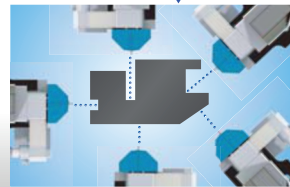

Ideal for dispensing in uneven or confined areas.



Gear teeth

Hard-to-access parts

**Missed shot detection function**

Detection unit for  
instantaneously checking of all shots

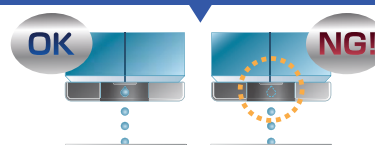

Detects dispensing failures or faulty dispensing with detection function, with results output as I/O signals.



Detection unit

## Example applications



Door lock components

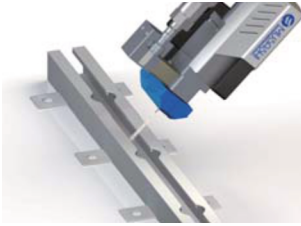

Seat rail parts

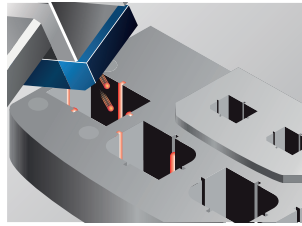

Instrument panel  
switch parts

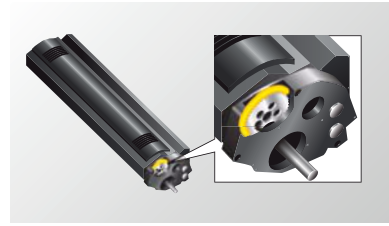

Toner cartridge parts

## MUSASHI's motion units, from fully automatic to semi automatic operation



Fully automatic Multi-purpose  
dispensing machine

**FAD™ 2500**



Multi-purpose  
vertical articulated robot

**Arm MASTER™**



Cartesian robot

**X CROSS  
MASTER™ Sx**

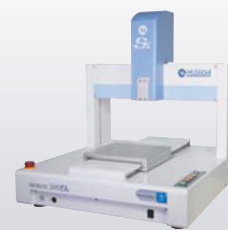

Desktop robot

**SHOTMASTER™ Sx**



Dispensing head unit  
rotation specifications



Work rotation  
specifications

### Greasejet dispensing system configuration and connection diagram Synchro

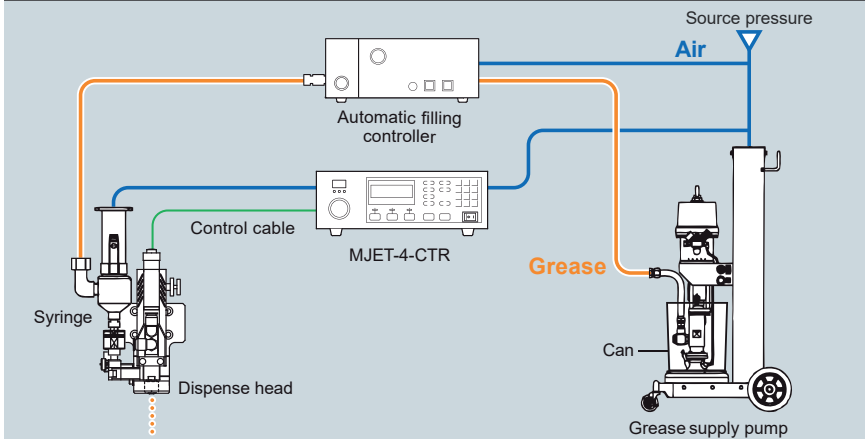

### Speed™ function

PAT.P

Maintains a fixed line width,  
regardless of robot speed.  
Achieves high-quality  
dispensing automatically,  
without the need for any  
complex adjustments.



Previous technology

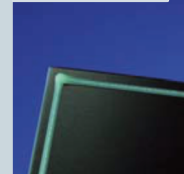

Newest technology

**Synchro Speed™  
function ON**

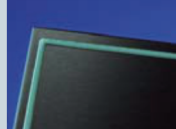

**⚠ Safety precautions**  
Please read the instruction manual carefully before use to ensure correct and safe usage.

\*These specifications are subject to change without any notice.  
\*The copyright of this catalog belongs to our company. Reproduction and  
distribution of the pictures, illustrations and any other information in this  
catalog to any other media without prior written permission are strictly  
prohibited; doing so will result in copyright infringement.

MUSASHI ENGINEERING, INC.  
(headquarters) is certified and  
registered according to the ISO  
9001 Quality Management System  
and the ISO 14001 Environmental  
Management System.



## Váš dodavatel Musashi pro Česko a Slovensko

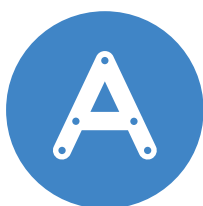

**Amtech**  
dispensing

AMTECH, spol. s r.o.

Tel.: +420 541 225 215

E-mail: [davkovani@amtech.cz](mailto:davkovani@amtech.cz)

Web: [www.amtech-dispensing.cz](http://www.amtech-dispensing.cz)

